

PROIMPLANT 3rd Gen

ENG INSTRUCTIONS FOR USE.



Set ProImplant 3rd Gen REF 1700774-001



Set ProImplant 3rd Gen REF 1700768-001



Options

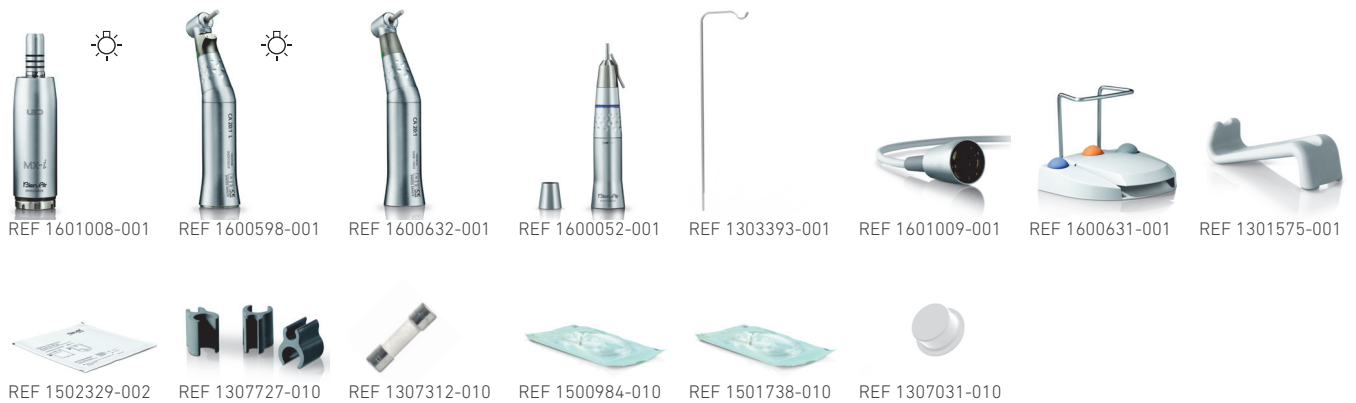























Table of contents















1	Symbols	2
1.1	Description of symbols for Prolmplant 3 rd Gen units	2
1.2	Description of symbols for Prolmplant 3 rd Gen accessories	2
2	Identification, Intended Use and Notation ..	3
2.1	Identification	3
2.2	Intended use	3
2.3	Intended patient population	3
2.4	Intended User	3
2.5	Intended medical conditions	3
2.6	Patient contra-indications and warnings	3
2.7	In case of accidents	3
2.8	Notation and chapter links	3
3	Warnings & Precautions of Use	4
3.1	General information	4
3.2	Warnings	4
4	Description	5
4.1	Prolmplant 3 rd Gen system overview	5
4.2	Sets supplied	6
4.3	Options	6
4.4	Technical data	6
4.5	Performance	7
4.6	Environmental protection and information for disposal	7
4.7	Electromagnetic compatibility (technical description)	8
4.7.1	Precautions of use	8
4.7.2	Electromagnetic compatibility warnings	8
4.7.3	Electromagnetic compatibility – emissions & immunity	8
5	Installation	10
5.1	Install the Prolmplant 3 rd Gen system	11
5.2	On/off procedure	11
6	Interface overview	12
6.1	Prolmplant 3 rd Gen modes	12
6.2	Rotating knob functions overview	12
6.3	Sound alerts	13
7	Operation	14
7.1	Operation screen description	14
7.2	Perform an operation, steps P1 and P2	14
7.3	Perform an operation, steps P3, P4 and P5	14
8	Settings	16
8.1	MX-i LED 3 rd Gen micromotor speed	16
8.2	MX-i LED 3 rd Gen micromotor torque	16
8.3	MX-i LED 3 rd Gen micromotor rotation direction	16
8.4	Irrigation level	17
8.5	Contra-angle ratio	17
9	Special modes	18
10	List of errors & Troubleshooting	20
10.1	Safety warning (operating)	20
10.2	Device operating error	21
11	Maintenance	22
11.1	Servicing	22
11.2	Cleaning & Sterilization	22
11.3	Important	23
11.4	Replacement of fuses	23
12	Terms of guarantee	24

1 Symbols

1.1 Description of symbols for Prolimplant 3rd Gen units

Symbol	Description	Symbol	Description
	CE Marking with number of the notified body.		General symbol for recovery/recyclable.
	OFF (power).		Separate collection of electric and electronic equipment.
	ON (power)		Manufacturer.
	Fuse.		Lamp; lighting, illumination.
	Alternating current.		Sound alerts.
	Non-ionizing electromagnetic radiation.		Warning: in accordance with federal law (USA), this device is only available for sale upon recommendation by an accredited practitioner.
	CAUTION: hazard that could result in light or moderate injury or damage to the device if the safety instructions are not correctly followed.		WARNING: hazard that could result in serious injury or damage to the device if the safety instructions are not correctly followed.
	Refer to instruction manual/booklet (https://dental.bienair.com/fr_ch/support/download-center/).		CSA marking - Complies with U.S. and Canadian standards.
	Catalogue number.		Serial number.
	Authorized EC Representative in the European Community.		Medical Device.
	Data Matrix code for product information including UDI (Unique Device Identification).		

1.2 Description of symbols for Prolimplant 3rd Gen accessories

Symbol	Description	Symbol	Description
	CE Marking with number of the notified body.		Thermo washer disinfectable.
	Expiration date.		General symbol for recovery/recyclable.
	Do not reuse.		Separate collection of electric and electronic equipment.
	Sterilized with Ethylene Oxide.		Sterilizable in autoclave up to the specified temperature.
	Electrical safety. Applied part type B.		Manufacturer.
	Catalogue number.		Serial number.
	Does not contain DEHP.		Batch code.
	Do not use if package is damaged.		

2 Identification, Intended Use and Notation

2.1 Identification

The ProImplant 3rd Gen device encompasses a table-top system for dental implantology allowing to control a dental micromotor which drives a dental handpiece. A peristaltic pump conveys the physiological liquid via a sterile single-use irrigation line. The console includes a single knob control to set the parameters and a foot control used to turn on/off the pump, to navigate through the various steps of the selected procedure and to control the rotation direction of the motor. The device's LCD display shows many parameters of the operation, such as the handpiece gear ratio, bur speed, torque value and irrigation flow setting.

2.2 Intended use

All ProImplant 3rd Gen devices are intended to be used in dental implantology.

The consoles are designed to operate a specific dental micromotor that drives dental handpieces fitted with appropriate tools to cut hard and soft tissues in the mouth and to screw dental implants.

The intended electromagnetic environment (per IEC 60601-1-2 ed. 4.0) is Professional healthcare facility environment.

2.3 Intended patient population

The intended patient population of the ProImplant 3rd Gen consoles includes any person visiting a dental practitioners' office to receive treatment in line with the intended medical condition. There is no restriction concerning subject age, race, or culture. The intended user is responsible to select the adequate device for the patient according to the specific clinical application.

2.4 Intended User

The ProImplant 3rd Gen is meant to be used only by dentists and dental surgeons in dental offices and hospitals.

2.5 Intended medical conditions

Dental implantology is the elective treatment to replace one or more missing teeth. Teeth can be missing for various reasons, such as traumas, partial or total edentulism, and advanced decay that leads to tooth sacrifice because restorative treatments are no longer possible.

Dental implantology requires to prepare jawbone to accommodate a dental implant, which is typically a titanium screw fitted with an abutment and a prosthetic crown made of ceramic material mimicking the natural missed tooth.

Multi-teeth prosthetic solutions are also available, usually supported by more than one single implant.

2.6 Patient contra-indications and warnings

No specific patient contra-indication nor warning exist for the ProImplant 3rd Gen device family when the device is used as intended.

2.7 In case of accidents

If an accident occurs, the ProImplant 3rd Gen must not be used until repairs have been completed by a qualified and trained technician authorized by the manufacturer.

If any serious incident occurs in relation to the device, report it to a competent authority of your country, as well as the manufacturer through your regional distributor. Observe relevant national regulations for detailed procedures.

2.8 Notation and chapter links

- **A, B, C**, etc.
Text preceded by a letter indicates a procedure to be carried out step-by-step.
- 
Indicates a procedure result.
- **(1), (2), (3)**, etc.
Text preceded by a number indicates text used in conjunction with an illustration.
- ***OK, Settings***, etc.
Text in bold italic font style indicates, on-screen elements such as buttons, menus, menu items, screen areas, values, fields when they are named and screen names.

In order to simplify the notation, in this manual:

- «Clockwise» is referred to as «CW»;
- «Counterclockwise» is referred to as «CCW»;
- Forward micromotor rotation mode is referred to as «FWD»;
- Reverse micromotor rotation mode is referred to as «REV»;
- Rotational speed unit «revolutions per minute» is referred to as «rpm»;
- Torque unit «newton centimetre» is referred to as «Ncm»;
- Micromotor control unit is referred to as «DMX».

3 Warnings & Precautions of Use

3.1 General information

The device must be used by qualified professionals in compliance with the current legal provisions concerning occupational safety, health and accident prevention measures, and these instructions for use. In accordance with such requirements, the operators:

- must only use devices that are in perfect working order; in the event of irregular functioning, excessive vibration, abnormal heating, unusual noise or other signs that may indicate malfunction of the device, the work must be stopped immediately; in this case, contact a repair center that is approved by Bien-Air Dental SA;
- must ensure that the device is used only for the purpose for which it is intended, must protect themselves, their patients and third parties from any danger.
- Avoid contact with liquids.

3.2 Warnings

⚠ CAUTION

Any use other than what is specified herein is unauthorized and may be dangerous.

⚠ CAUTION

The power plug is used for disconnection in case of problems, it must be easily accessible at all times.

⚠ CAUTION

Never connect a handpiece on a running MX-i LED 3rd Gen micromotor.

⚠ CAUTION

Any modification of the medical device is strictly forbidden.

⚠ CAUTION

The device is not designed for use in an explosive atmosphere (anaesthetic gas).

⚠ WARNING

Do not attempt to open the device when it is connected to the electric mains.

Risk of electrocution.

⚠ CAUTION

The parameters contained in the dental procedures are indicative only. Bien-Air Dental SA cannot be held liable for them.

⚠ CAUTION

The device must not be touched by the patient.

⚠ CAUTION

Do not simultaneously touch the patient and the electrical connections of the unit.

⚠ CAUTION

Ensure that there is no water under the unit before switching it on.

⚠ CAUTION

All connectors must be dry before use. Ensure the absence of residual moisture due to cleaning.

⚠ WARNING

To avoid the risk of electric shock, this equipment must only be connected to supply mains with protective earth.

⚠ WARNING

To avoid any risk of contamination, only control the device via the foot control during surgical procedures. If the removable knob is used during the surgical procedure and / or comes into contact with potentially contaminated surfaces or liquids, follow the procedure for the cleaning and sterilization of the knob described in section 11.

4 Description

4.1 Prolmplant 3rd Gen system overview

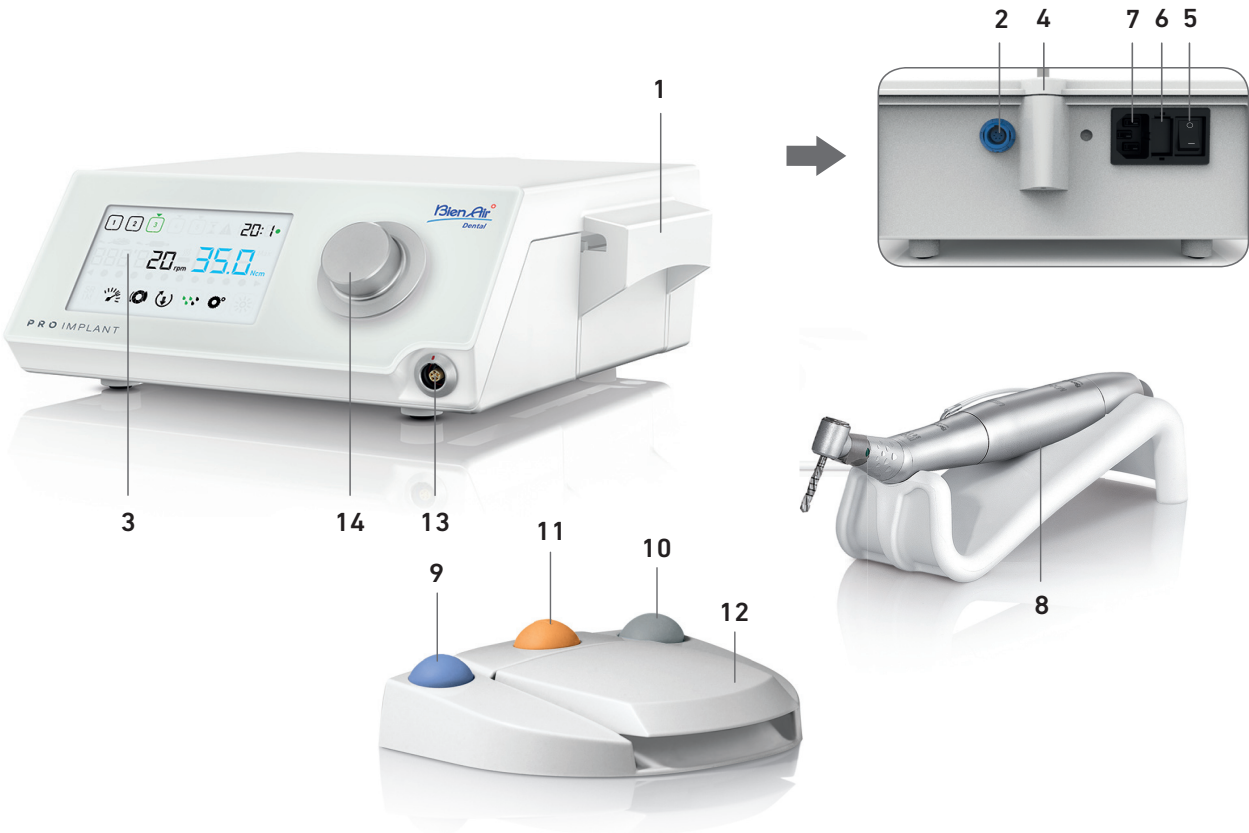

FIG. 1

- (1) Peristaltic pump lid
- (2) Foot control connector
- (3) Marking
- (4) Bracket support
- (5) Main switch
- (6) Fuse box
- (7) Mains connector
- (8) MX-i LED 3rd Gen micromotor
- (9) Button to start/stop irrigation
- (10) Button to reverse the rotation of the MX-i LED 3rd Gen micromotor
- (11) "Program" button to go to next operation step
- (12) Motor start
- (13) MX-i LED 3rd Gen micromotor connector
- (14) Control knob
- (15) LCD control screen

4.2 Sets supplied

Prolmplant 3rd Gen set REF 1700774-001

Designation	REF number
Prolmplant 3 rd Gen unit (1x)	1601101-001
MX-i LED 3 rd Gen micromotor (1x)	1601008-001
3-button pedal (1x)	1600631-001
Cable MX-i LED 3 rd Gen (2m) (1x)	1601009-001
Sterile protective sheet (2x)	1502329-002
Pack of 5 disposable sterile irrigation lines	1500984-005
Pack of 10 attachment collars for fastening the sterile irrigation line to a cable	1307727-010
Bracket for fluid bottle (1x)	1303393-001
Handpiece support (1x)	1301575-001
Contra-angle handpiece CA 20:1 (1x)	1600632-001

Prolmplant 3rd Gen set REF 1700768-001

Designation	REF number
Prolmplant 3 rd Gen unit (1x)	1601101-001
MX-i LED 3 rd Gen micromotor (1x)	1601008-001
3-button pedal (1x)	1600631-001
Cable MX-i LED 3 rd Gen (2m) (1x)	1601009-001
Sterile protective sheet (2x)	1502329-002
Pack of 5 disposable sterile irrigation lines	1500984-005
Pack of 10 attachment collars for fastening the sterile irrigation line to a cable	1307727-010
Bracket for fluid bottle (1x)	1303393-001
Handpiece support (1x)	1301575-001
3P cable system, US/Asia, length 2m (1x)	1300067-001
Contra-angle handpiece CA 20:1 L (light) (1x)	1600598-001

4.3 Options

Designation	REF number
3-button foot control	1600631-001
MX-i LED 3 rd Gen micromotor	1601008-001
Contra-angle handpiece CA 20:1	1600632-001
Contra-angle handpiece CA 20:1 L (light)	1600598-001
Straight handpiece PM 1:1 Micro-Series	1600052-001
Sterile protective sheet	1502329-002
Pack of 10 disposable sterile lines 3.5 m	1501738-010
Pack of 10 disposable sterile lines	1500984-010
Bracket for fluid bottle	1303393-001
Handpiece support	1301575-001
Cable MX-i LED 3 rd Gen (2m)	1601009-001

Designation	REF number
Pack of 10 attachments collars for fastening the sterile irrigation line to a cable	1307727-010
Pack of 10 fuses T4.0AH 250 VAC high breaking capacity	1307312-010
Knob	1307031-001

4.4 Technical data

Dimensions L x W x H

Prolmplant 3 rd Gen unit.....	240 x 240 x 102 mm
Prolmplant 3 rd Gen unit (with bracket).....	240 x 240 x 482 mm
Foot control (without handle).....	206 x 180 x 60 mm
Foot control (with handle).....	206 x 200 x 155 mm
Motor cable (REF 1601009).....	L 2.0 m
Foot control cable.....	L 2.9 m
MX-i LED 3rd Gen micromotor	23 x 84 mm

The Foot control is waterproof (IP X8 in accordance with IEC 60529).

Weight

Prolmplant 3 rd Gen unit.....	2.2 kg
Foot control (without handle and cable).....	830 g
Foot control (with handle and cable).....	877 g
Bracket	115 g
Cable	105 g
MX-i LED 3rd Gen micromotor	110 g

Electrical data

Voltage	100 – 240 VAC
Frequency	50-60 Hz

Environmental conditions

Storage	
Temperature range:	0°C / +40°C
Relative humidity range:	10% - 80%
Air pressure range:	650 hPa - 1060 hPa
Transport	
Temperature range:	-20°C / +50°C
Relative humidity range:	5% - 80%
Air pressure range:	650 hPa - 1060 hPa
Operating temperature	
Temperature range:	+ 5°C / + 35°C
Relative humidity range:	30% - 80%
Air pressure range:	700 hPa – 1060 hPa

⚠ CAUTION

Do not use ProImplant 3rd Gen outside the range of operating temperature.

Classification

Class IIa in accordance with European Regulation (EU) 2017/745 concerning medical devices.

Electric insulation class

Class I per IEC 60601-1 (apparatus protected against electric shocks).

⚠ CAUTION

The device must be only used by the operator.

Applied parts (per IEC 60601-1):

MX-i LED 3 rd Gen micromotor	REF 1601008-001
Straight handpiece 1:1	REF 1600052-001
CA 20:1 L	REF 1600598-001
CA 20:1 L Micro-Series	REF 1600692-001
CA 20:1 L KM	REF 1600785-001
CA 20:1 L KM Micro-Series	REF 1600786-001
Irrigation lines	REF 1500984-010
KM Irrigation lines	REF 1501635-010

Degree of ingress protection

UNIT.....IP 41 (protection against insertion of objects larger than 1mm and dripping water (vertically falling drops))

Foot control.....IP X8

Memory

Memory storage of 5 steps settings including adjustment of speed, torque, rotation direction, irrigation, and contra-angle ratio for each step.

Languages

English.

Bracket for physiological liquid flask

Stainless steel.

Peristaltic pump

Pump deliveryFrom 30 to 130 ml/min.
(5 levels)

Hose for pumpExternal Ø 5.60 mm

.....Internal Ø 2.40 mm

Wall thickness1.60 mm

Intended for use with: See instructions for use

MX-i LED 3rd Gen micromotorREF 2100245

Cable MX-i LED 3rd GenREF 2100163

Contra-angle CA 20:1 L, light.....REF 2100209

Contra-angle CA 20:1 L

Micro-Series, light.....REF 2100209

Contra-angle CA 20:1 L KM, light.....REF 2100209

Contra-angle CA 20:1 L KM

Micro-Series, light.....REF 2100209

Straight Handpiece 1:1REF 2100046

⚠ CAUTION

The use of the system with other handpieces, motors or cables has not been validated/certified (speed and torque values are not guaranteed in this case).

List of errors & Troubleshooting

See chapter "10 List of errors & Troubleshooting" on page 20.

4.5 Performance

Performance	REF 1600995
Motor speed regulation	Accuracy ± 5% in the speed range 100 - 40'000 rpm (*)
Motor torque regulation	Torque adjustable from 10% to 100% of the maximum torque
Maximum motor torque	5 (±5%) Ncm (*)
Maximum motor power	95 (±10%) W (*)
Max motor LED current	250 (± 10%) mA rms
Max motor LED current range	Not adjustable, always at full intensity
Power supply output limitation	< 150 W
Irrigation flow	5 levels: 1 drop = 30ml/min 2 drops = 60ml/min 3 drops = 90ml/min 4 drops = 120ml/min 5 drops = 130ml/min

(*) Measurement realized in combination with motors MX-i LED 3rd Gen 1601008 and MX-i LED 1600755, contra-angle CA 20:1 L Micro Series 1600692 and/or handpiece PML 1121 1600156. The maximum torque is measured at 1000 rpm with irrigation stopped and it corresponds to a maximum torque of 70 Ncm at the rotative tool if the motor is combined with the contra-angle CA 20:1 L Micro Series 1600692.

In accordance with 80601-2-60, no essential performance is linked to this dental equipment.

4.6 Environmental protection and information for disposal



The disposal and/or recycling of materials must be performed in accordance with the legislation in force.



Separate collection of electric and electronic equipment and accessories in view of recycling.

Electrical and electronic equipment may contain dangerous substances which constitute health and environmental hazards. The user must return the device to its dealer or establish direct contact with an approved body for treatment and recovery of this type of equipment (European Directive 2012/19/EU).

4.7 Electromagnetic compatibility (technical description)

4.7.1 Precautions of use

This electronic control is in compliance with electrical safety standards in line with standard IEC 60601-1, edition 3.1, and those governing electromagnetic compatibility in line with standard IEC 60601-1-2, fourth edition.

4.7.2 Electromagnetic compatibility warnings

⚠ CAUTION

The Prolmplant 3rd Gen complies with the EMC requirements according to IEC 60601-1-2. Radio transmitting equipment, cellular phones, etc., should not be used in the immediate vicinity of the device, since this could affect its operation. The device is not suitable for being used close to high-frequency surgical equipment, magnetic resonance imaging (MRI) and other similar devices where the intensity of electromagnetic disturbances is high. In any case, ensure that no high frequency cables are routed above or near the device. If in doubt, contact a qualified technician or Bien-Air Dental SA.

Portable RF communications equipment (including peripherals such as antenna cables and external antennas) should be used no closer than 30 cm (12 inches) to any part of the Prolmplant 3rd Gen, including cables specified by the manufacturer. Otherwise, degradation of the performance of this equipment could result.

⚠ CAUTION

The use of accessories, transducers and cables other than those specified, with the exception of transducers and cables sold by Bien-Air Dental SA as spare parts for internal components, may result in increased emissions or decreased immunity.

4.7.3 Electromagnetic compatibility – emissions & immunity

Guidance and manufacturer's declaration – Electromagnetic emissions

The Prolmplant 3rd Gen is intended for use in the electromagnetic environment specified below. The customer or the user of the Prolmplant 3rd Gen must ensure that it is actually used in such an environment.

Emissions test	Compliance	Electromagnetic environment - guidance
RF emissions CISPR 11	Group 1	The Prolmplant 3 rd Gen uses RF energy for its internal operation only. Therefore, its RF emissions are very low and are not likely to cause any interference in nearby electronic equipment.
RF emissions CISPR 11	Class B	The Prolmplant 3 rd Gen is suitable for use in any building, including residential buildings and those directly connected to the public low-voltage power supply network that supplies buildings used for residential purposes.
Harmonic emissions IEC 61000-3-2	Class A	
Emissions due to voltage fluctuations IEC 61000-3-3	Conforming	

Guidance and manufacturer's declaration – Electromagnetic immunity

The Prolmplant 3rd Gen is intended for use in the electromagnetic environment specified below. The customer or the user of the Prolmplant 3rd Gen must ensure that it is actually used in such an environment.

Immunity test	IEC 60601 test level	Compliance level	Electromagnetic environment - guidance
Electrostatic discharge (ESD) IEC 61000-4-2	±8 kV contact ±2 kV air ±4 kV air ±8 kV air ±15 kV air	±8 kV contact ±2 kV air ±4 kV air ±8 kV air ±15 kV air	Floors should be wood, concrete or ceramic tile. If floors are covered with synthetic material, the relative humidity should be at least 30%.
Electrical fast transient/burst IEC 61000-4-4	±2 kV for power supply lines ±1 kV for other lines	±2 kV for power supply lines N.A.	Mains power quality should be that of a commercial or hospital environment.
Surge IEC 61000-4-5	±0.5 kV line to line ±1 kV line to line ±0.5 kV line to earth ±1 kV line to earth ±2 kV line to earth	±0.5 kV line to line ±1 kV line to line ±0.5 kV line to earth ±1 kV line to earth ±2 kV line to earth	Mains power quality should be that of a commercial or hospital environment.

Immunity test	IEC 60601 test level	Compliance level	Electromagnetic environment - guidance	
Voltage dips, short interruptions and voltage variations on power supply input lines IEC 61000-4-11	0% U_T for 0.5 cycle, at 0°, 45°, 90°, 135°, 180°, 225°, 270° and 315° 0% U_T for 1 cycle and 70% U_T for 25/30 cycles at 0° 0% U_T for 250 cycles at 0°	0% U_T for 0.5 cycle, at 0°, 45°, 90°, 135°, 180°, 225°, 270° and 315° 0% U_T for 1 cycle and 70% U_T for 25/30 cycles at 0° 0% U_T for 250 cycles at 0°	Mains power quality should be that of a commercial or hospital environment. If the user of the Prolimplant 3 rd Gen requires continued operation during mains power interruptions, it is recommended that the Prolimplant 3 rd Gen be powered from an uninterruptible power supply or a battery.	
Magnetic field due to mains frequency (50/60 Hz) IEC 61000-4-8	30 A/m	30 A/m	Magnetic fields generated by the mains frequency should be at levels characteristic of a typical location in a typical commercial or hospital environment.	
Conducted disturbances induced by RF fields IEC 61000-4-6	3 V_{RMS} 0,15 MHz – 80 MHz 6 V_{RMS} in ISM bands 0,15 MHz – 80 MHz 80% AM at 1 kHz	3 V_{RMS} 0,15 MHz – 80 MHz 6 V_{RMS} in ISM bands 0,15 MHz – 80 MHz 80% AM at 1 kHz	Field strengths from fixed RF transmitters, as determined by an electromagnetic site survey ^a should be less than the compliance level in each frequency range. Interference may occur in the vicinity of equipment marked with the following symbol:	
Radiated RF EM fields IEC 61000-4-3	3 V/m 80 MHz – 2,7 GHz 80 % AM at 1 kHz	3 V/m 80 MHz – 2,7 GHz 80 % AM at 1 kHz		
Proximity fields from RF wireless communications equipment IEC 61000-4-3	Test freq. [MHz]	Max. power [W]	Immunity test level [V/m]	Distance: 0.3 m
	385	1.8	27	
	450	2	28	
	710, 745, 780	0.2	9	
	810, 870, 930	2	28	
	1720, 1845, 1970	2	28	
	2450	2	28	
5240, 5500, 5785	0.2	9		
NOTE: U_T is the AC mains voltage prior to application of the test level.				

a. Field strengths from fixed transmitters, such as base stations for radio (cellular/cordless) telephones and mobile field radios, amateur radios, AM and FM radio broadcasts and TV broadcasts cannot be predicted theoretically with accuracy. To assess the electromagnetic environment due to fixed RF transmitters, an electromagnetic site survey should be considered. If the measured field strength in the location in which the Prolimplant 3rd Gen is used exceeds the RF compliance level mentioned above, the Prolimplant 3rd Gen should be observed to verify that it is operating normally. If abnormal operation is observed, additional measures may be necessary, such as reorienting or relocating the Prolimplant 3rd Gen.

5 Installation



FIG. 1

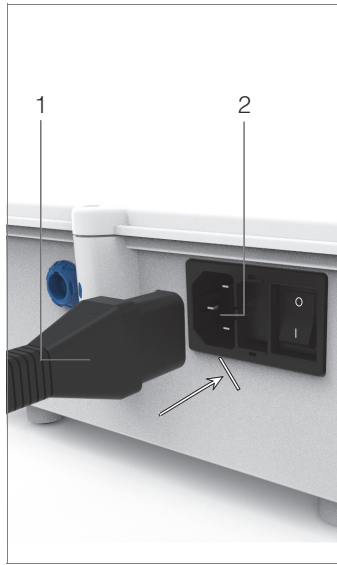

FIG. 2

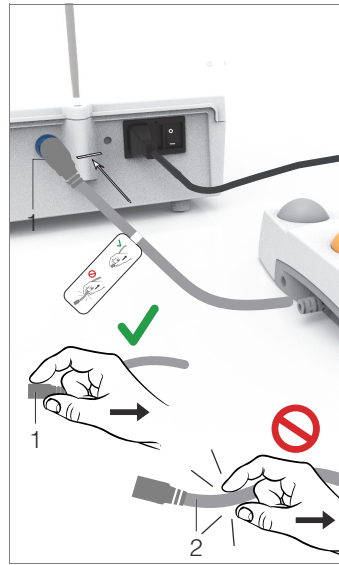

FIG. 3



FIG. 4

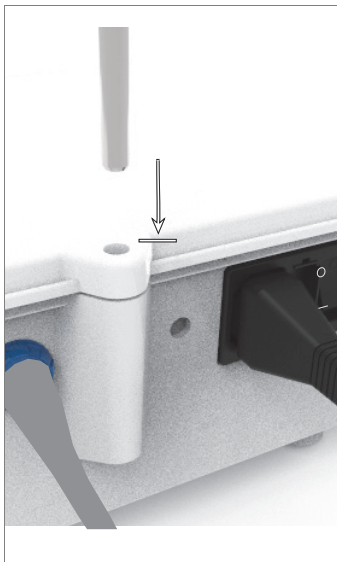

FIG. 5

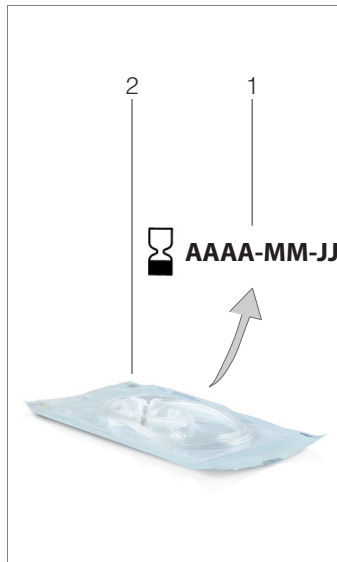

FIG. 6

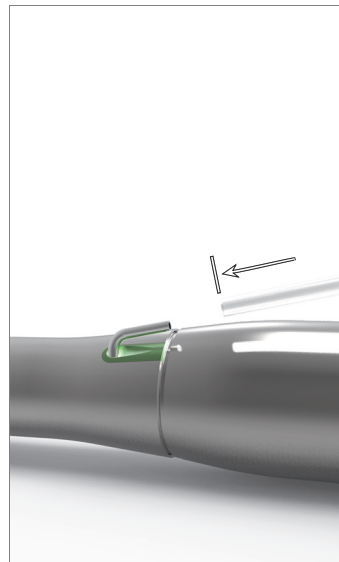

FIG. 7



FIG. 8

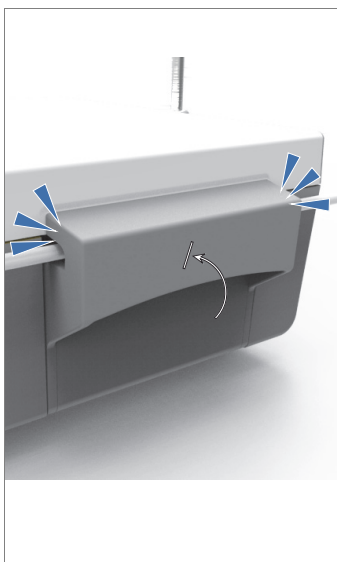

FIG. 9



FIG. 10

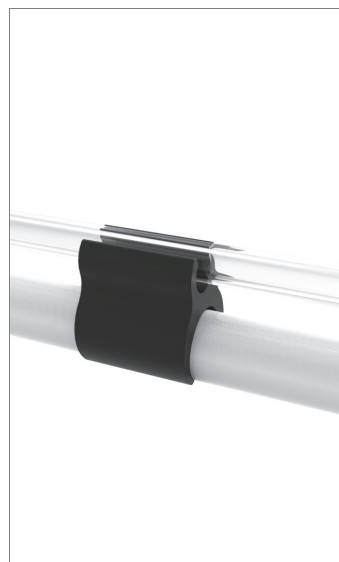

FIG. 11

5.1 Install the ProImplant 3rd Gen system

FIG. 1

- A. Place the ProImplant 3rd Gen on a flat surface capable of bearing its weight.

⚠ CAUTION

It may be positioned on a table, on a trolley or any other surface but in no circumstances on the floor.

FIG. 2

- B. The fuse box may be opened with a screwdriver.
100 - 240 VAC = fuse T4.OAH 250 VAC REF 1307312-010.

To replace a fuse, see chapter "11.4 Replacement of fuses" on page 23.

- C. Connect the power cable (1) to the connector (2).

Note 1

FIG. 3

- D. Connect the foot control cable to the input provided on the rear panel, guiding the connector and plug by means of the index pin on the connector.

⚠ CAUTION

Do not lift the foot control holding the connection cable.
To disconnect the foot control cable pull the cable socket connector (1).
Do not pull the cable (2) without disconnecting the cable socket before.

FIG. 4

- E. Connect the MX-i LED 3rd Gen micromotor cable to the motor output, guiding the connector and plug by means of the index pin on the connector.

FIG. 5

- F. Align and attach the bracket to the housing provided on the rear of the console and suspend the flask or bottle.

FIG. 6

- G. Check the packaging integrity, as well as the expiry date of the irrigation line on the label (1).

⚠ WARNING

The medical device must be used only with lines supplied by Bien-Air Dental to ensure trouble-free operation. These lines are sterile and for single use. Re-use may result in microbiological contamination of the patient.

- H. Remove the single-use sterile irrigation line (2) from its pouch.

FIG. 7

- I. Connect the flexible hose of the irrigation line to the spray tube of the handpiece or contra-angle.

FIG. 8

- J. Install the peristaltic cassette (1) in the peristaltic pump (2). Check that the cassette is clipped correctly.

FIG. 9

- K. Close the pump lid (3). If there is resistance to closing, open the lid again and check the correct positioning of the cassette. When the lid is correctly closed, the user should hear a click sound.

⚠ CAUTION

Do not run the pump while the lid is open.

⚠ CAUTION

Do not run the pump without irrigation line.

⚠ CAUTION

Risk of pinching!

FIG. 10

- L. Perforate the cap of the physiological liquid flask with the pointed end of the irrigation line after removing the protective cap.

⚠ CAUTION

There is no detection of empty physiological liquid flask! Always check the content of the flask before operating.

FIG. 11

- M. Attach the irrigation line on the motor cable using the 3 attachment collars REF 1307727-010.

5.2 On/off procedure

The device can be switched on and off in complete safety using the main switch on the ProImplant 3rd Gen.

⚠ CAUTION

Do not switch off the device while the motor is running.

NOTES

- 1 The equipment is powered by the mains power supply (100 - 240 VAC / 150W / 50-60Hz).

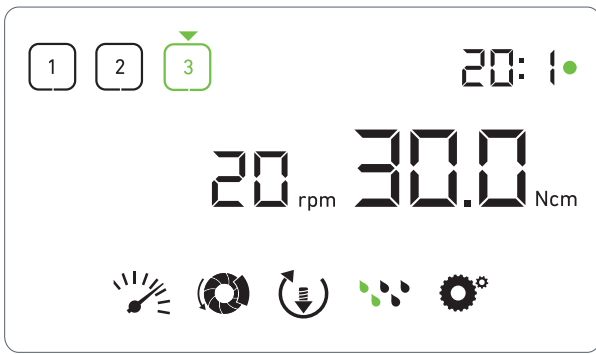

FIG. 1

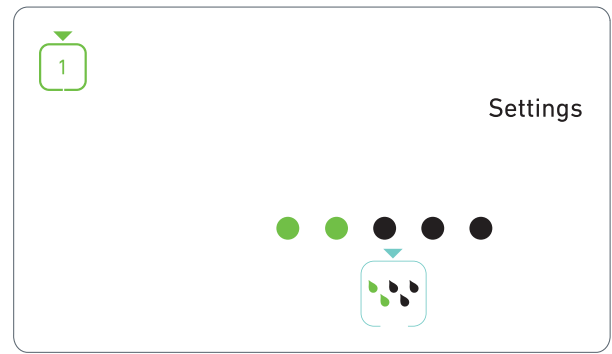

FIG. 2

6 Interface overview

6.1 ProImplant 3rd Gen modes

The ProImplant 3rd Gen allows to visualize and control operation parameters by the means of the LCD display.

A unique screen allows to use the following modes:

FIG. 1

- Operation mode (to perform an operation in 3 steps)

See chapter "7 Operation" on page 14 for details.

FIG. 2

- Settings mode (to set up operation parameters)

See chapter "8 Settings" on page 16 for details.

FIG. 3

- Special modes (to test system and reset settings)

See chapter "9 Special modes" on page 18 for details.

FIG. 4

A. Long press on the rotating knob (1) to switch between Operation and Settings modes.

Note 1

See chapter "6.2 Rotating knob functions overview" on page 12 for details.

See chapter "9 Special modes" on page 18 for entering special modes.

6.2 Rotating knob functions overview

Note 2

Knob action	Description
CW rotation	Increase current value, go to the element on the right
CCW rotation	Decrease current value, go to the element on the left
One short press (Operation mode)	Go to the next programmed step, acknowledge error messages
One short press (Settings mode)	Enter selected setting, validate and store the current setting value, exit the current setting, acknowledge error messages
One long press	Switch between Operation and Settings modes
Double short press	Enter special modes (only when gear ratio is selected in settings mode)

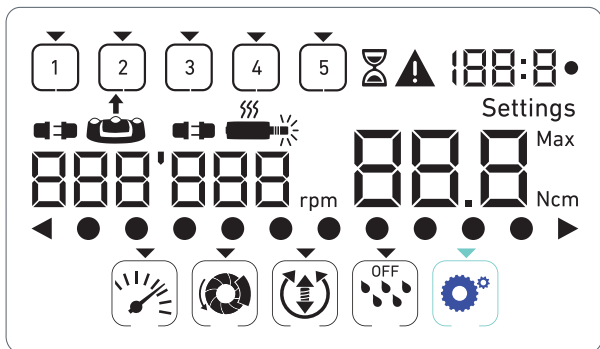

FIG. 3



FIG. 4

6.3 Sound alerts



Sound alert	Description
One short beep	Activating irrigation, going to next step, and switching rotation direction to FORWARD
Two short beeps	Deactivating irrigation, and switching rotation direction to REVERSE
Two long beeps	Switching from low speed to high speed programmed step
Alternate short beeps	Warning notifications
Alternate medium beeps	Micromotor REVERSE running indicator
Alternate long beeps	System failure notification

NOTES

- 1 The Operation mode is the default startup mode.
- 2 Any knob or foot control action will be ignored when the motor is running.

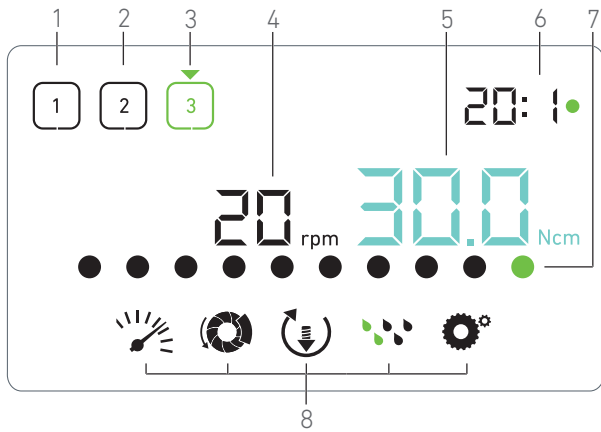

FIG. 1

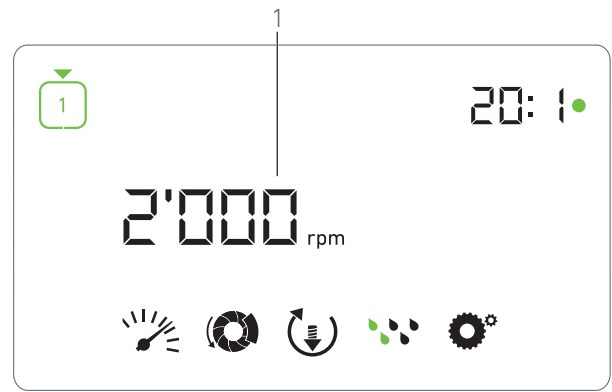

FIG. 2

7 Operation

7.1 Operation screen description

FIG. 1

The Operation screen differs whether the micromotor is stopped or running and depending on the active step.

It allows to perform an operation in 3, 4 or 5 predefined steps P1, P2, P3, P4, P5 (which can respectively be used to program settings for the bone preparation, drilling, threading and implant insertion phases), and displays the following information:

- (1) Step P1 (inactive step, in black)
- (2) Step P2 (inactive step, in black)
- (3) Step P3 (active step, in green)

P4 and P5 steps are disabled by default, see "Number of steps" on page 18 for enabling them.

- (4) Speedometer

Note 1

- (5) Torquemeter

Note 2

- (6) Contra-angle ratio

Note 3

- (7) Bar graph for torque

Note 4

- (8) Operation settings symbols

See chapter "8 Settings" on page 16 for details on adjusting settings.

7.2 Perform an operation, steps P1 and P2

FIG. 2

A. Operate by pressing the foot control to adjust the MX-i LED 3rd Gen micromotor speed.

↳ Inactive steps symbols turn off when the motor is running.

↳ Speedometer displays real-time speed value in black.

Note 5 - 6 - 7

FIG. 3

B. If necessary, release the foot control to perform the following actions:

↳ Speedometer (1) displays the set micromotor maximum reachable speed in cyan.

- Turn the knob CW or CCW to respectively increase or decrease the micromotor maximum reachable speed (quick setting mode).

↳ The speedometer is cyan and displays the set micromotor maximum reachable speed (1).

Note 8

- Long press on the knob to change operation settings.

↳ The Settings mode is displayed.

See chapter "8 Settings" on page 16 for details.

- Long press on the orange button to activate the 5 Ncm torque boost.

Note 9

C. Short press on the foot control's orange button or on the knob to go to the next step.

↳ The next step symbol turns green and the step's last used settings are restored.

Note 7 - 10

7.3 Perform an operation, steps P3, P4 and P5

FIG. 4

A. In steps P3 (1), P4 and P5, operate by pressing the foot control to adjust the MX-i LED 3rd Gen micromotor speed.

↳ All inactive steps symbols turn off when the motor is running.

↳ Speedometer (2) displays real-time value.

↳ Torquemeter (3) displays real-time value.

↳ The torque bar (5) displays ratio between the real-time torque value (represented by cyan dots when the micromotor is running) and the maximum reached torque (represented by green dot).

Note 5 - 6 - 7

B. If necessary, release the foot control to perform the following actions:

↳ Torquemeter (3) displays maximum reached value together with the **Max** symbol (4).

↳ Torque bar (5) dots that were displayed in cyan turn black, except for the maximum value dot which turns green.

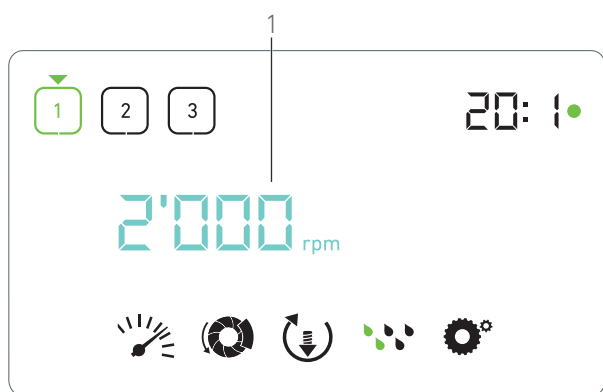

FIG. 3

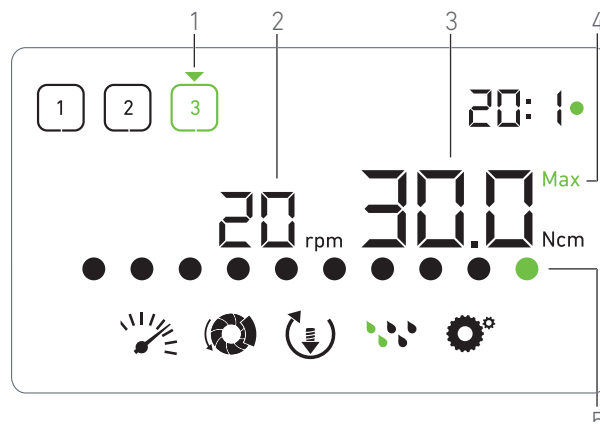

FIG. 4

- Turn the knob CW or CCW to respectively increase or decrease the micromotor maximum reachable torque (quick setting mode).

↳ The torquemeter (3) turns cyan and displays the set micromotor maximum reachable torque.

Note 11

- Long press on the knob to change operation settings.

See chapter "8 Settings" on page 16 for details.

- Long press on the orange button to activate the 5 Ncm torque boost.

Note 9

C. Short press on the foot control's orange button or on the knob to go to the next step.

↳ The next step symbol turns green and the step's last used settings are restored.

Note 7 - 10

NOTES

1 Real-time speed value is displayed in black when the MX-i LED 3rd Gen micromotor is running. Maximum reachable speed value stored is displayed in cyan when the MX-i LED 3rd Gen micromotor is not running, in steps P1 and P2.

2 Torquemeter is only displayed when micromotor speed is below 100 RPM in steps P1 and P2.

3 The contra-angle ratio is cyan-colored for direct-drive and green-colored for reduction gears.

4 Torque bar graph is only displayed when micromotor speed is below 100 RPM.

5 Each step settings are restored from the corresponding step last used settings, excluding quick settings made directly in the Operation mode.

6 In REVERSE mode, the rotation direction symbol  blinks and there is a sound alert (alternate medium beeps). The Torque value is automatically increased in REVERSE mode when torquemeter is displayed. The torque value can be increased from 0 to 10 Ncm, see chapter see "Reverse torque boost value" on page 18 to adjust it.

7 Actions on foot control's buttons have no effect when the micromotor is running.

8 Changing the torque in steps P1 or P2 can only be performed through the Settings mode.

9 The torque boost can only be activated when the torquemeter is displayed in Operation mode, in low speed steps (<100 RPM).

10 For safety reasons, the speed setting icon turns red and blinks together with the speedometer for 2 seconds when switching from low speed to high speed (≥ 100 RPM) step.

11 Changing the speed in steps P3, P4 and P5 can only be performed through the settings mode.

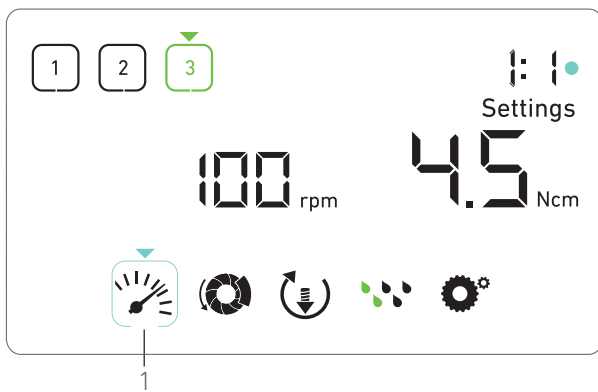

FIG. 1

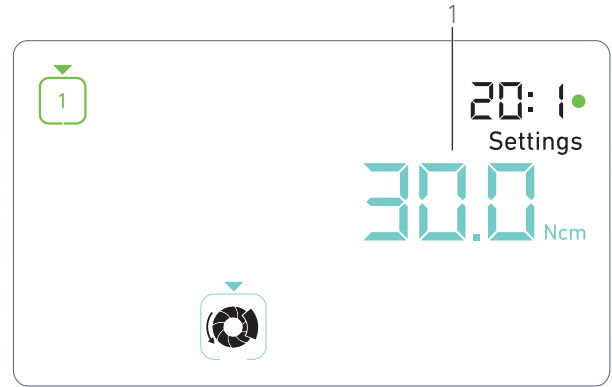

FIG. 2

8 Settings

FIG. 1

The Settings mode allows changing all parameters of each step. It is accessed by long pressing the knob from the Operation mode and leaved by also long pressing the knob or by running the motor.

All changes made in this mode are automatically saved for the corresponding step.

Note 1

- From the Settings mode menu, navigate through the operation parameters by turning the knob CW or CCW.
- The selected parameter symbol (1) is encased in a cyan square and an arrow points on it.
- If necessary, short press on the foot control's orange button to go to the next step without going back to the Operation mode.
- The Settings mode is still displayed, the next step symbol turns green and the step's last used settings are restored.
- Short press on the knob to change the selected parameter setting (setting sub-mode).
- The selected setting sub-mode is displayed.

8.1 MX-i LED 3rd Gen micromotor speed

- From the Settings mode menu, select the  symbol and short press on the knob to change maximum reachable speed.

FIG. 2

- Turn the knob CW or CCW to respectively increase or decrease micromotor maximum reachable speed.
- The speedometer (1) displays the set maximum reachable speed.
- Short press on the knob to exit speed setting.
- New maximum reachable speed is saved and the Settings mode menu is displayed again, FIG. 1.

8.2 MX-i LED 3rd Gen micromotor torque



- From the Settings mode menu, select the  symbol and short press on the knob to change maximum reachable torque.



FIG. 3

- Turn the knob CW or CCW to respectively increase or decrease micromotor maximum reachable torque.
- The torquemeter (1) displays the set maximum reachable torque.
- Short press on the knob to exit torque setting.
- New maximum reachable torque is saved and the Settings mode menu is displayed again, FIG. 1.

8.3 MX-i LED 3rd Gen micromotor rotation direction

- From the Settings mode menu, select the  symbol and short press on the knob to change rotation direction.

Note 1

- Turn the knob CW or CCW to alternatively toggle between FORWARD  and REVERSE  micromotor rotation.
- Short press on the knob to exit rotation direction setting.
- Rotation direction is saved and the Settings mode menu is displayed again.

Note 2

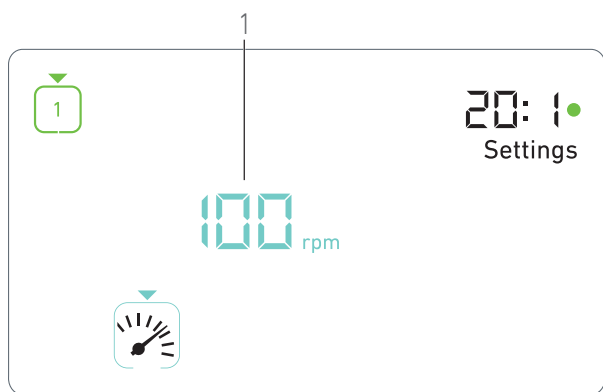

FIG. 3

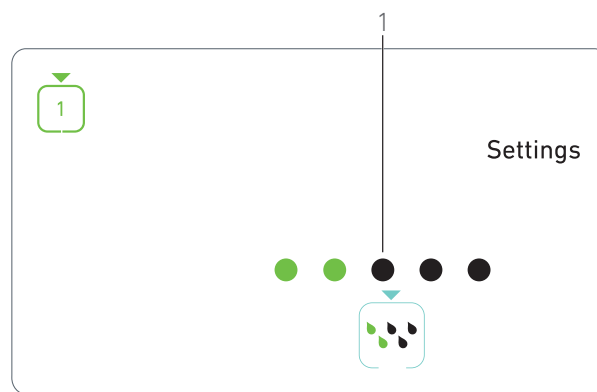



FIG. 4

8.4 Irrigation level

- A. From the Settings mode menu, select the  symbol and short press on the knob to change irrigation level.

Note 1

FIG. 4

- B. Turn the knob CW or CCW to set up the irrigation level (1).
5 levels of adjustment are possible:
30ml/min, 60ml/min, 90ml/min, 120ml/min,
130ml/min.

Note 3

- C. Short press on the knob to exit irrigation level setting.

- ↳ Irrigation level is saved and the Settings mode menu is displayed again.

8.5 Contra-angle ratio

- A. From the Settings mode menu, select the  symbol and short press on the knob to change the contra-angle ratio.

- B. Turn the knob CW or CCW to change the contra-angle ratio.

Note 4

- C. Short press on the knob to exit the contra-angle ratio setting.

- ↳ The contra-angle ratio is saved and the Settings mode menu is displayed again.

NOTES

1 The rotation direction and the irrigation level symbols differ depending on the actual settings.

2 The Torque value is automatically increased in REVERSE mode when torquemeter is displayed. The torque value can be increased from 0 to 10 Ncm, see chapter "Reverse torque boost value" on page 18 to adjust it.

3 When setting the irrigation level to OFF, all dots (1) are displayed in black. Irrigation level is off when the irrigation is completely turned off by means of the foot control's blue button, regardless of the active step. In this case, the OFF symbol is displayed in Operation mode. The irrigation is considered as a quick setting and therefore is turned ON when starting again from step P1.

4 The contra-angle ratio is cyan-colored for direct-drive and green-colored for reduction gears.

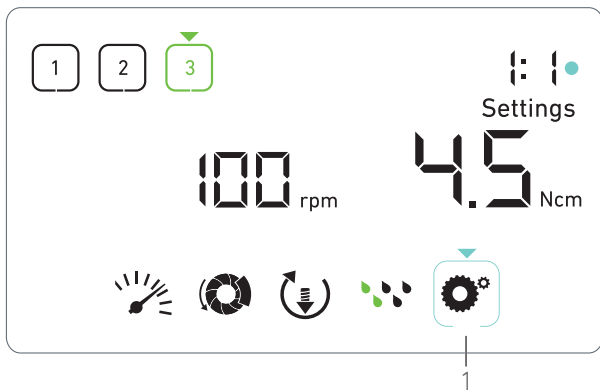

FIG. 1

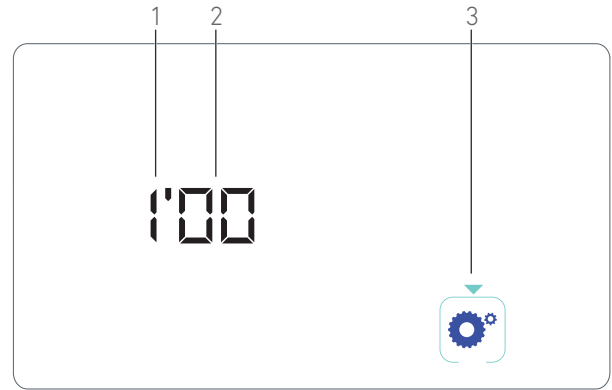

FIG. 2

9 Special modes

The special modes allow to, in the following order:

- Display software version;
- Test LCD display;
- Define number of steps (3, 4 or 5);
- Define reverse torque boost value;
- Restore factory settings.

Note 1

A. From the Operation mode, long press on the rotating knob to enter Settings modes.

↻ The Settings mode is displayed.

FIG. 1

B. Turn the knob CW or CCW to select the contra-angle ratio symbol  (1).

↻ The contra-angle ratio symbol is encased in a cyan square and an arrow points on it.

Software version

FIG. 2

C. Double short press on the knob to enter special modes.

↻ The contra-angle ratio symbol (3) turns blue to differentiate it from the ratio change cyan symbol.

↻ The software version is displayed as following:

- (1) Major version
- (2) Minor version

LCD display test

FIG. 3

D. Short press on the knob to test LCD display.

↻ All dots are displayed in black, except for the contra-angle ratio symbol (1).

Number of steps

E. Short press on the knob to define the number of steps.

↻ The step number screen is displayed.

F. Turn the knob CW or CCW to alternatively display the **3**, **4** or **5** text.

G. Short press on the knob to define the number of steps.

Reverse torque boost value

Reverse torque boost allows an automatic increase of torque value when in REVERSE mode, in order to ease bur rotation when stuck.

H. Short press on the knob to define reverse torque boost value.

↻ The reverse torque boost screen is displayed.

I. Turn the knob CW or CCW to alternatively display the **0**, **5** or **10** text.

J. Short press on the knob to define no boost value when **0** is displayed, or short press on the knob to respectively define 5 Ncm or 10 Ncm boost value when **5** or **10** is displayed.

Settings reset

FIG. 4

K. Short press on the knob to display factory settings reset screen.

↻ The factory settings reset screen is displayed.

L. Turn the knob CW or CCW to alternatively display the **reset yes** or **reset no** text (1).

Note 3

M. Short press on the knob to restore factory settings when the **reset yes** text is displayed, or short press to go back to the Settings mode when the **reset no** text is displayed.

↻ Reset can take up to 2 seconds. Meanwhile, the  symbol is displayed, and the **yes** text is turned off. When reset is done, the Settings mode is displayed again.

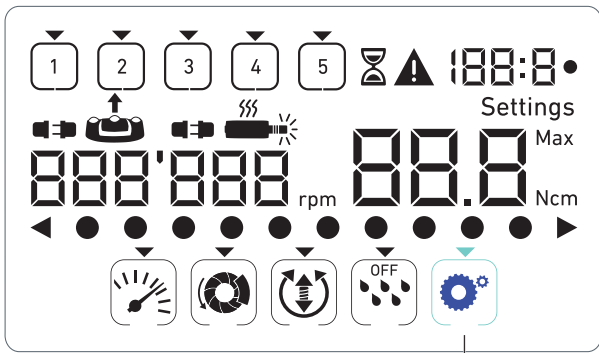

FIG. 3

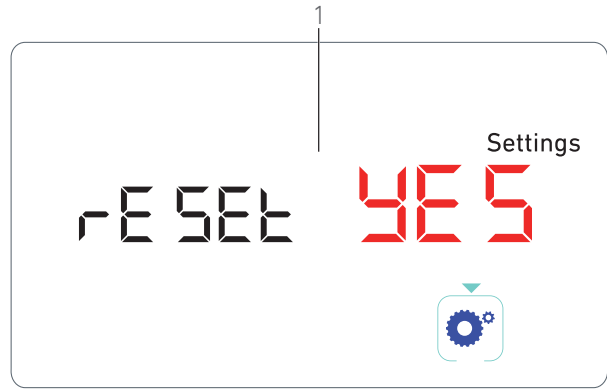







FIG. 4

NOTES

- 1 Pressing the foot control has no effect in the Special modes.
- 2 Go through all the special modes to display the Settings mode again.
- 3 The **reset no** text is displayed by default.

10 List of errors & Troubleshooting

10.1 Safety warning (operating)

Warning description	Message	Cause of warning	Action
Motor overheating		Excessive power demand of the MX-i LED 3 rd Gen micromotor.	Avoid extended use. Let system cool down.
Release pedal [foot control]		<ul style="list-style-type: none"> Foot control is pressed when accessing settings sub-modes. Foot control is pressed during device startup. Foot control is pressed after recovering from an error. 	<ul style="list-style-type: none"> Confirm setting by pressing the knob. Release foot control and press it again. Release foot control and press it again.
Low to high speed step transition	 Speedometer blinking.	User switches from low speed to high speed (≥ 100 RPM) step.	No action needed, the warning disappears after 2 seconds.
Motor jammed		Motor is jammed for more than 2 seconds. Motor power supply is cut to avoid overheating.	Release foot control, release the bur and press foot control again.
Foot pedal [foot control] not connected		Foot control is not connected to device.	Connect foot control to the device.
Motor not connected		Motor is not properly connected to device, Motor hardware is damaged.	<ol style="list-style-type: none"> Acknowledge error. (Re)connect the motor cable. If problem persists, contact Bien-Air Dental SA.

10.2 Device operating error

Error description	Cause of error	When	Action
ERROR 1			
Motor short-circuit	Electrical failure: short-circuit between motor phases.	In running mode.	Replace motor and/or cable.
ERROR 2			
Main controller error	Other fault condition detected by software.	Any time.	1. Switch off system. 2. Contact Bien-Air Dental SA.
ERROR 3			
Motor driver communication timeout error	Failure of DMX controller. Failure of main controller RS-232.	In running mode.	1. Switch off system. 2. Contact Bien-Air Dental SA.
ERROR 4			
Invalid EEPROM memory	Failure of EEPROM memory.	Any time.	Contact Bien-Air Dental SA. Acknowledging this error allows the operator to work normally but it will not allow settings to be saved or restored. This error will appear at each save or restoration attempt.
ERROR 5			
Motor drive over temperature	Motor overload in a high temperature environment. Failure of DMX controller.	Any time.	1. Wait for system cooling. 2. If problem persists, contact Bien-Air Dental SA.
ERROR 6			
Motor driver under voltage error	Motor overload in a high temperature environment. Failure of power supply.	Any time.	1. Acknowledge error. 2. If problem persists, contact Bien-Air Dental SA.
ERROR 7			
Motor driver over voltage error	Failure of power supply. Tool used has a too high inertia.	Any time.	1. Acknowledge error. 2. If problem persists, contact Bien-Air Dental SA.
ERROR 8			
Irrigation pump general failure	Electrical failure: short-circuit to ground or to supply. Electrical failure: short-circuit between motor phases.	In running mode.	1. Switch off system. 2. Contact Bien-Air Dental SA.
ERROR 9			
Knob failure	Electrical failure of knob encoder.	Any time.	1. Switch off system. 2. Contact Bien-Air Dental SA.



FIG. 1

11 Maintenance

⚠ CAUTION

Only use original Bien-Air Dental maintenance products and parts or those recommended by Bien-Air Dental. Using other products or parts may cause operational failure and/or void the guarantee.

11.1 Servicing

⚠ CAUTION

Never disassemble the device. For any modification and repair, we recommend that you contact your regular supplier or Bien-Air Dental SA directly.

Service period

The device was tested by simulating 10,000 clinical procedures (corresponding to a service period of 6 to 10 years). If the actual use of the device exceeds the tested service period, preventive maintenance of the device is recommended.

Note 1

11.2 Cleaning & Sterilization

⚠ CAUTION

- Do not immerse in disinfectant solution.
- Not designed for an ultrasonic bath.

⚠ WARNING

- Use a new sterile irrigation line for each patient.
- Use a new sterile protective sheet for each patient.

FIG. 1

Cleaning

A. Remove the knob (1) and rinse it twice with running tap water (15°C-38°C) provided that the local tap water has a pH within the range of 6.5 - 8.5 and a chloride content below 100 mg/l. If the local tap water does not meet these requirements, use demineralized (deionized) water instead.

Note 2

B. Clean the unit including the bracket, the foot control and the external and internal surfaces of the knob by gently rubbing it with a clean cloth soaked in a suitable product (i.e. Bien-Air Dental Spraynet or isopropyl alcohol for about 15 sec.).

Sterilization of the knob

⚠ CAUTION

Before using for the first time clean and sterilize the knob.

⚠ CAUTION

The quality of the sterilization is highly dependent on how clean the instrument is. Only perfectly clean instruments should be sterilized.

⚠ CAUTION

Do not use a sterilization procedure other than the one described below.

Procedure

⚠ CAUTION

Pack the device in a packaging approved for steam sterilization.

⚠ CAUTION

Only use dynamic air removal cycles: pre-vacuum or steam flush pressure pulse (SFPP) cycles.

Sterilize using steam, following dynamic air removal cycle (ANSI/AAMI ST79, Section 2.19), i.e. air removal via forced evacuation (ISO 17665- 1, ISO/TS 17665-2) at 135°C (275°F), for 3 minutes. In jurisdictions where sterilization for prions is required, sterilize at 135°C for 18 minutes.

The recommended parameters for the sterilization cycle are:

- The maximum temperature in the autoclave chamber does not exceed 137°C, i.e. the nominal temperature of the autoclave is set at 134°C, 135°C or 135.5°C taking into account the uncertainty of the sterilizer as regards temperature.
- The maximum duration of the interval at the maximum temperature of 137°C is in accordance with national

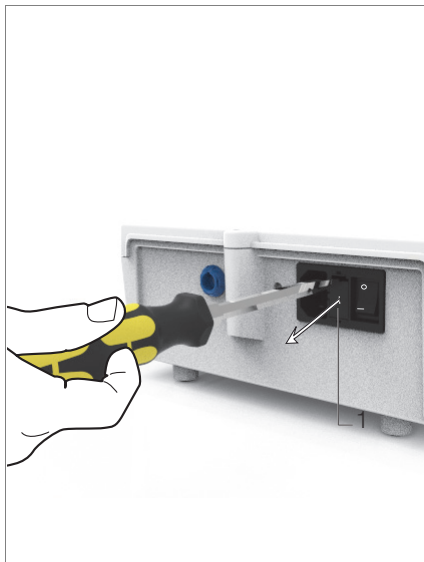

FIG. 2

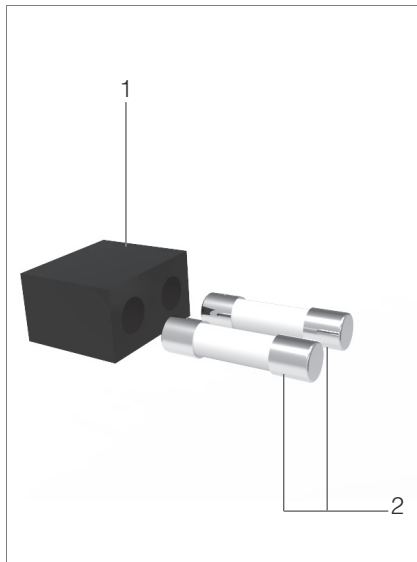

FIG. 3

requirements for moist heat sterilization and does not exceed 30 minutes.

- The absolute pressure in the chamber of the sterilizer is comprised in the interval between 0.07 bar to 3.17 bar (1 psia to 46 psia).
- The rate of change of temperature does not exceed 15°C/min for increasing temperature and -35°C/min for decreasing temperature.
- The rate of change of pressure does not exceed 0.45 bar/min (6.6 psia/min) for increasing pressure and -1.7 bar/min (-25 psia/min) for decreasing pressure.
- No chemical or physical reagents are added to the water steam.

11.3 Important

For maintenance: See instructions for use
 MX-i LED 3rd Gen micromotor REF 2100245
 Cable for micromotor REF 2100163
 Contra-angle CA 20:1 L, light REF 2100209
 Contra-angle CA 20:1 L
 Micro-Series, light REF 2100209
 Contra-angle CA 20:1 L KM, light REF 2100209
 Contra-angle CA 20:1 L KM
 Micro-Series, light REF 2100209
 Straight Handpiece 1:1 REF 2100046

11.4 Replacement of fuses

- Switch off the Prolimplant 3rd Gen unit.
- Disconnect the mains cable.

⚠ CAUTION

The power cable must be disconnected at least 10 seconds before opening the fusebox.

FIG. 2

- Remove the fuse box (1) with a flat screwdriver.

FIG. 3

- Replace the fuses (2) by the new ones and put the fuse box back (1) in place.

⚠ CAUTION

Only use fuses T4.0AH 250 VAC REF 1307312-010.

NOTES

- 1 Bien-Air Dental SA asks the user to check the relevant IFU for the dynamic devices inspection.
- 2 The knob is hold magnetically. There is no need to preserve its angular position when removing it or putting it back in place.

12 Terms of guarantee

Bien-Air Dental SA grants the user a guarantee covering all functional defects, material or production faults.

The device is covered by this guarantee from the date of invoicing for:

- 12 months for the motor cable;
- 24 months for the Prolmplant 3rd Gen unit and CA 20:1 L Micro-Series;
- 36 months for the MX-i LED 3rd Gen micromotor.

In case of justified claim, Bien-Air Dental SA or its authorized representative will fulfill the company's obligations under this guarantee by repairing or replacing the product free of charge. Any other claims, of whatever nature, in particular in the form of a claim for damages and interest, are excluded.

Bien-Air Dental SA shall not be held responsible for damage or injury and the consequences thereof, resulting from:

- excessive wear and tear
- improper use
- non-observance of the instructions for installation, operation and maintenance
- unusual chemical, electrical or electrolytic influences
- poor connections, whether of the air, water or electricity supply.

The guarantee does not cover flexible "optical fiber" type light conductors, or any parts made of synthetic materials.

The guarantee shall become null and void if the damage and its consequences are due to improper manipulation of the product, or modifications to the product carried out by persons not authorized by Bien-Air Dental SA.

Claims under the terms of the guarantee will be considered only on presentation, together with the product, of the invoice or the consignment note, on which the date of purchase, the product reference and the serial no. should be clearly indicated.

Please refer to the General Terms and Conditions of Sale on www.bienair.com.



Bien-Air Dental SA

Länggasse 60 Case postale 2500 Bienne 6 Switzerland

Tel. +41 (0)32 344 64 64 Fax +41 (0)32 344 64 91

dental@bienair.com

Other addresses available at

www.bienair.com

EC REP Bien-Air Europe Sàrl

19-21 rue du 8 mai 1945

94110 Arcueil

France